

VDI DESTRO
VDI Right hand
VDI Recht

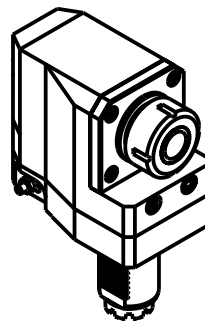

VDI SINISTRO
VDI Left hand
VDI Link

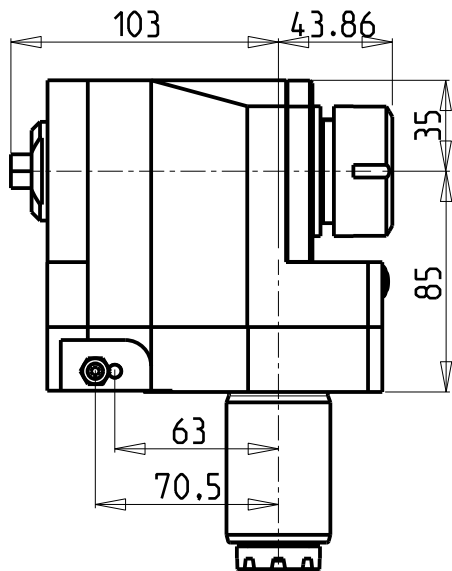
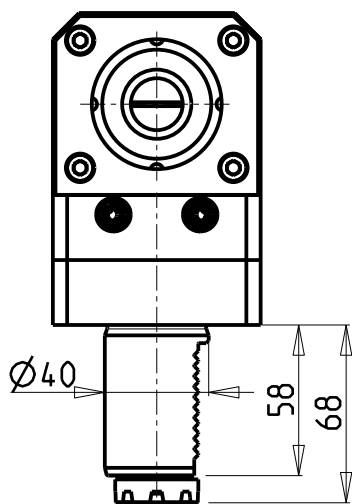
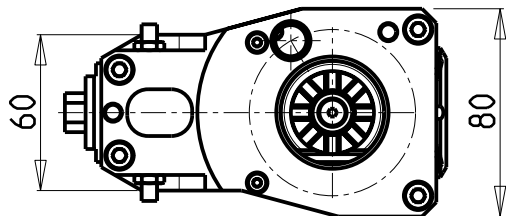
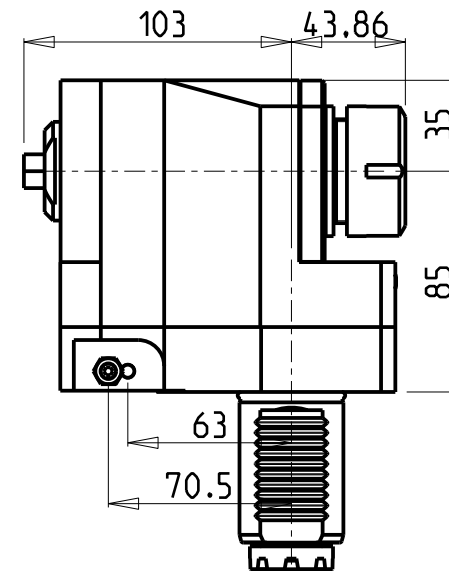
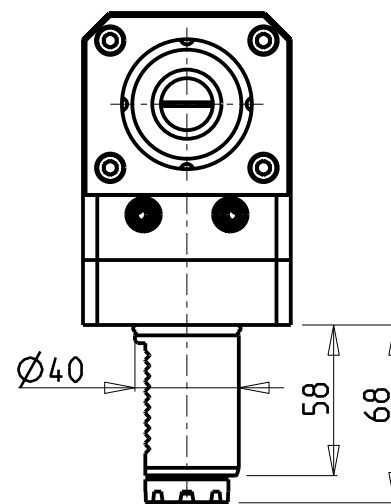
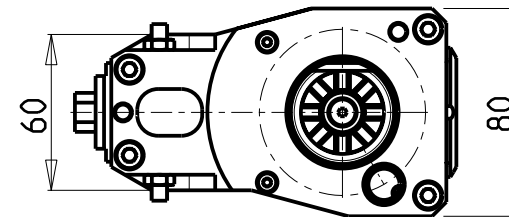

Cod. MT	Mandrino Spindle Spindel	i	RPM	Coppia Max Max Torque Max Drehmoment	Lubrificazione est. Ext. coolant Aussenkuehlung	CHIAVI NON INCLUSE Keys not included Schluessel nicht einbegriffen		VDI
						CHSTER32	CHUB13	
161BAR_R32_40C00	ER32	1:1	4000	70Nm	X	CHSTER32	CHUB13	DESTRO - Right - Recht
161BAR_R32_40C20	ER32	1:1	4000	70Nm	X	CHSTER32	CHUB13	SINISTRO - Left - Link

BARUFFALDI
VDI 40

MODULO MOTORIZZATO RADIALE ARRETRATO VDI40 H=85mm
Radial rear-set driven tool VDI40 H=85mm
Radial angetriebenes Werkzeug zurueckversetzt VDI40 H=85mm

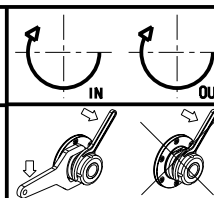

M.T. srl
Via Casino Albini 480
Tel. 0541/956034-957884
Fax 0541/956341
47842 S. GIOVANNI IN M. (RN)
e-mail: mtma@mtmarchetti.com
http://www.mtmarchetti.com



BAR013-2-00

Subject to change without notice.

03/2024