

versione dx
right version
version rechts

versione sx
left version
version links

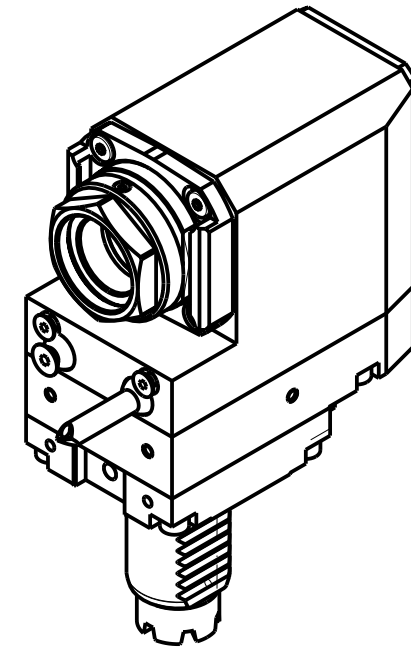
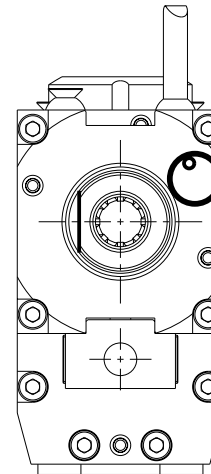
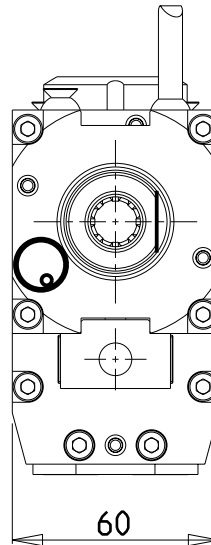

PER PORTAUTENSILI MODULARI MTSK-32 VEDI PAG. TBL300-1-32
FOR MTSK-32 QUICK CHANGE TOOLHOLDERS CLAMPINGS SEE PAGE TBL300-1-32
FUER MTSK-32 MODULARE WERKZEUGAUFNAHMEN SIEHE SEITE TBL300-1-32

- Chiave inclusa
- Key included
- Schlüssel inbegriffen

Cod. MT		Mandrino Spindle Spindel	i	RPM	Coppia Max Max Torque Max Drehmoment	Lubrificazione int. Coolant through Innenkuehlung	Lubrificazione est. Ext. coolant Aussenkuehlung	B	CHIAVI NON INCLUSE Keys not included Schlüssel nicht einbegriffen	
versione dx right version version rechts	versione sx left version version links								C HUB36	OKU0290009 ■
BAR0160132	BAR0161132	MTSK-32	1:1	6000	32Nm	-	X	73.5	C HUB36	OKU0290009 ■
BAR0160232	BAR0161232	MTSK-32	1:1	6000	32Nm	P=70bar	X	83.5	C HUB36	OKU0290009 ■

BARUFFALDI
VDI 30
MODULO MOTORIZZATO RADIALE ARRETRATO MTSK VDI30 H=85mm
Radial MTSK rear-set driven tool VDI30 H=85mm
Radial MTSK angetriebenes Werkzeug zurueckversetzt VDI30 H=85mm

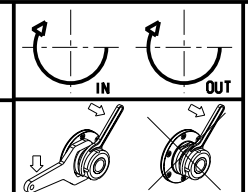

M.T. srl
Via Casino Albini 480
Tel. 0541/956034-957884
Fax 0541/956341
47842 S. GIOVANNI IN M. (RN)
e-mail: mtma@mtmarchetti.com
http://www.mtmarchetti.com



PAGINA BAR015-1-70-K

Subject to change without notice.

09/2023