

VDI SINISTRO
VDI Left hand
VDI Link

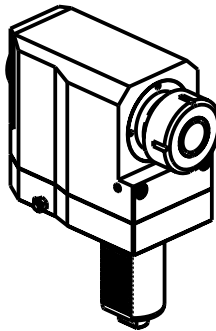

VDI DESTRO
VDI Right hand
VDI Recht

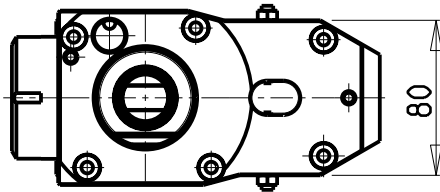
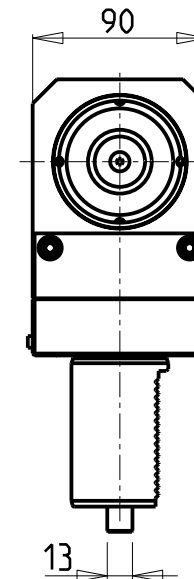
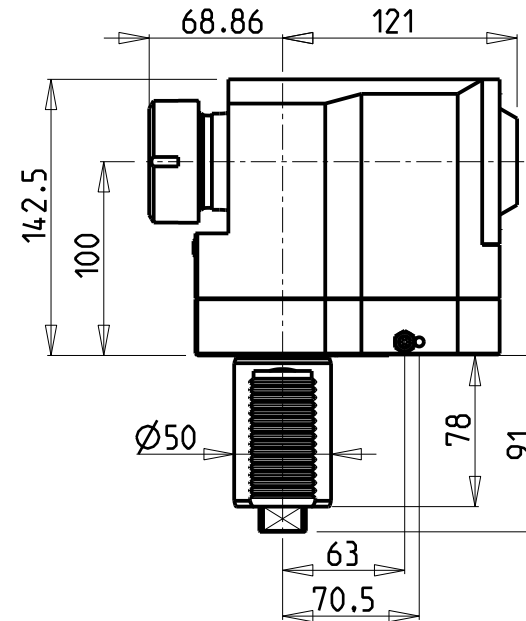
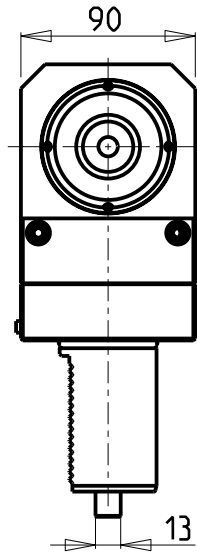
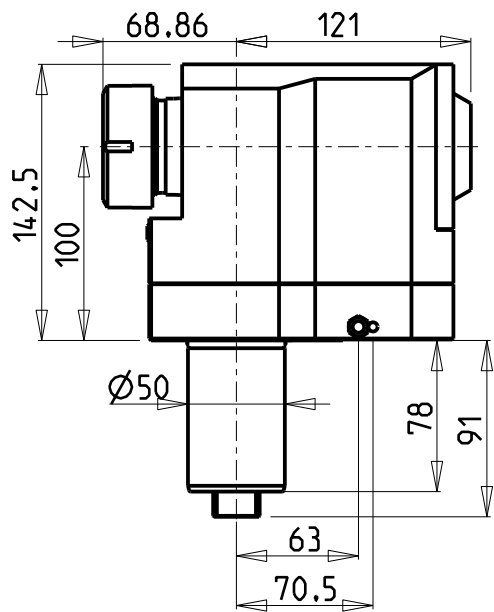
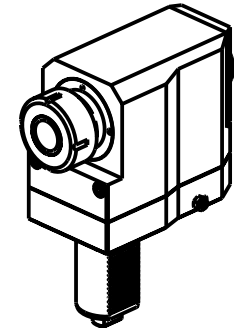
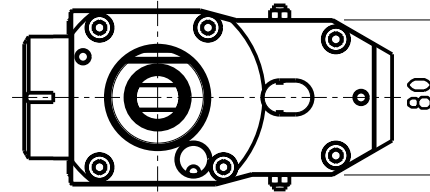

Cod. MT	Mandrino Spindle Spindel	i	RPM	Coppia Max Max Torque Max Drehmoment	Lubrificazione est. Ext. coolant Aussenkuehlung	CHIAVI NON INCLUSE Keys not included Schlüssel nicht einbegriffen		VDI
						CHSTER40	CHUB42	
151DUP_R40_50A20	ER40	1:1	4000	100Nm	X	CHSTER40	CHUB42	SINISTRO - Left - Link
151DUP_R40_50A00	ER40	1:1	4000	100Nm	X	CHSTER40	CHUB42	DESTRO - Right - Recht

DIPLOMATIC
VDI 50

MODULO MOTORIZZATO RADIALE VDI50
Radial driven tool VDI50
Radial angetriebenes Werkzeug VDI50

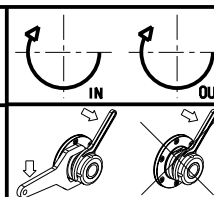

M.T. srl
Via Casino Albini 480
Tel. 0541/956034-957884
Fax 0541/956341
47842 S. GIOVANNI IN M. (RN)
e-mail: mtma@mtmarchetti.com
http://www.mtmarchetti.com



DUP010-3-00

Subject to change without notice.

03/2024