

versione dx
right version
version rechts

versione sx
left version
version links

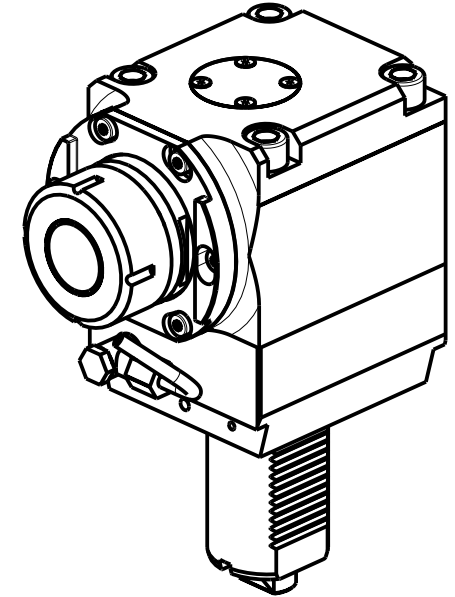
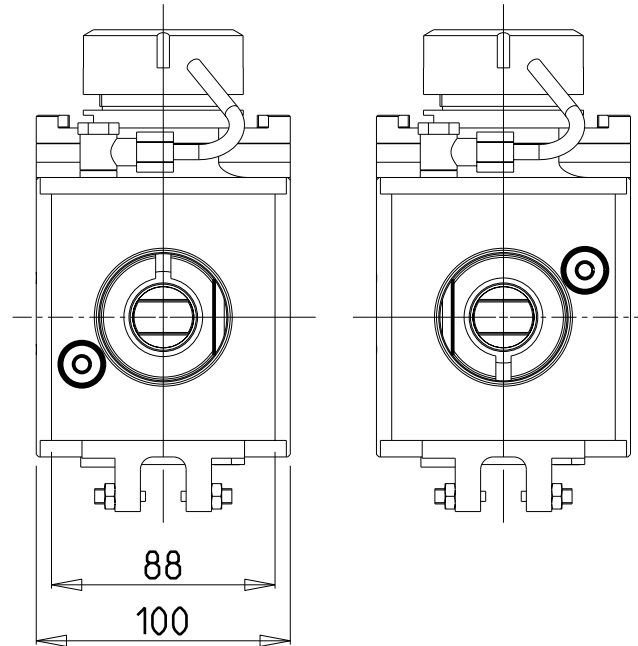

- Chiave inclusa
- Key included
- Schlüssel inbegriffen

Cod. MT		Mandrino Spindle Spindel	i	RPM	Coppia Max Max Torque Max Drehmoment	Lubrificazione int. Coolant through Innenkuehlung	Lubrificazione est. Ext. coolant Aussenkuehlung	B	CHIAVI NON INCLUSE Keys not included Schlüssel nicht einbegriffen	
versione dx right version version rechts	versione sx left version version links								CHSTER40	OKU0430007 *
DUP0200140	DUP0201140	ER40	1:1	4000	100Nm	-	X	58	CHSTER40	OKU0430007 *
DUP0200240	DUP0201240	ER40	1:1	4000	100Nm	P=70bar	X	66.5	CHSTER40	OKU0430007 *

DIPLOMATIC
VDI 50

MODULO MOTORIZZATO RADIALE VDI50
Radial driven tool VDI50
Radial angetriebenes Werkzeug VDI50

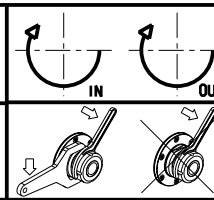

M.T. srl
Via Casino Albini 480
Tel. 0541/956034-957884
Fax 0541/956341
47842 S. GIOVANNI IN M. (RN)
e-mail: mtma@mtmarchetti.com
http://www.mtmarchetti.com

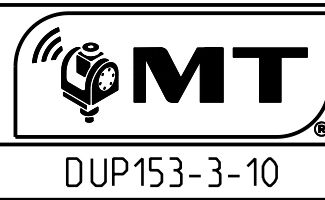

Subject to change without notice.

03/2024