

**ATTENZIONE - ATTENTION - ACHTUNG**

- VERIFICARE LE MISURE DI INGOMBRO PER POSSIBILE INTERFERENZA SU ALCUNI MODELLI DI MACCHINE
- Please check the overall sizes for possible interferences on some machine models
- Bitte überprüfen sie das ausmass um mögliche interferenzen auf einigen maschinen modellen zu vermeiden

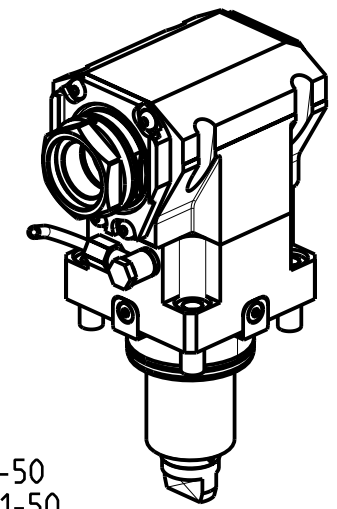

- Chiave inclusa
- Key included
- Schluessel inbegriffen

PER PORTAUTENSILI MODULARI MTSK-40 VEDI PAG. TBL300-1-40 E PER MTSK-50 VEDI PAG. TBL300-1-50  
 FOR MTSK-40 QUICK CHANGE TOOLHOLDERS CLAMPINGS SEE PAGE TBL300-1-40 AND FOR MTSK-50 SEE PAGE TBL300-1-50  
 FUER MTSK-40 MODULARE WERKZEUGAUFNAHMEN SIEHE SEITE TBL300-1-40 UND FUER MTSK-50 SIEHE SEITE TBL300-1-50

Cod. MT	Mandrino Spindel Spindel	I	RPM	Coppia Max Max Torque Max Drehmoment	Reversibile lato mandrino/contromandrino Reversible sub/main spindle side Umkehrbare Spindel-seite/ Gegenspindel-seite	Lubr.interna Coolant through Innenkuehlung	Lubr.esterna Ext. coolant Aussenkuehlung	A	B	CHIAVI NON INCLUSE Keys not included Schluessel nicht einbegriffen	
DW 02530140	MTSK-40	1:1	6000	100Nm	X	-	X	77	54	CHUB46	OKU0650004 •
DW 02530240	MTSK-40	1:1	6000	100Nm	X	P=70bar	X	77	65	CHUB46	OKU0650004 •
DW 02530150	MTSK-50	1:1	6000	100Nm	X	-	X	79	54	CHUB55	OKU0650004 •
DW 02530250	MTSK-50	1:1	6000	100Nm	X	P=70bar	X	79	65	CHUB55	OKU0650004 •

HAAS  
 MOD: ST20/25/28/30/35 (BMT65) - DS30 (BMT65)

MODULO MOTORIZZATO ASSIALE MTSK H=95mm  
 Axial MTSK driven tool H=95mm  
 Axial MTSK angetriebenes Werkzeug H=95mm

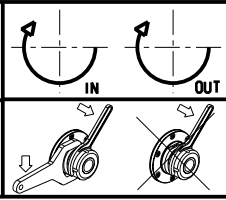

**M.T. srl**  
 Via Casino Albini 480  
 Tel. 0541/956034-957884  
 Fax 0541/956341  
 47842 S. GIOVANNI IN M. (RN)  
 e-mail: mtma@tmarchetti.com  
 http://www.tmmarchetti.com



HAS150-4-18-K

Subject to change without notice.