

-COMPATIBILE CON UTENSILI COMMERCIALI AD INSERTI
 -COMPATIBLE WITH COMMERCIAL INSERT CUTTING-TOOLS
 -KOMPATIBEL MIT HANDELSÜBLICHEN SCHNEIDWERKZEUGEN

ATTENZIONE - ATTENTION - ACHTUNG

- VERIFICARE LE MISURE DI INGOMBRO PER POSSIBILE INTERFERENZA SU ALCUNI MODELLI DI MACCHINE
- Please check the overall sizes for possible interferences on some machine models
- Bitte überprüfen sie das ausmass um mögliche interferenzen auf einigen maschinen modellen zu vermeiden

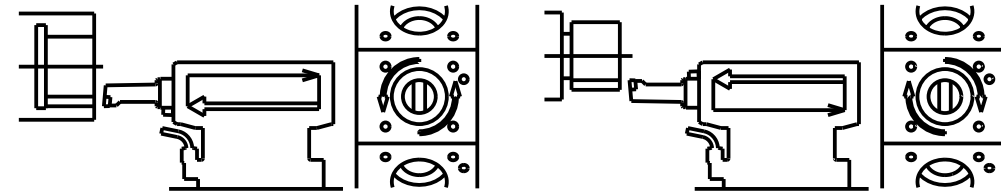
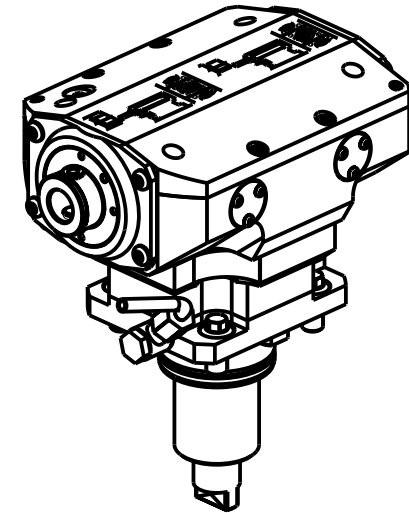
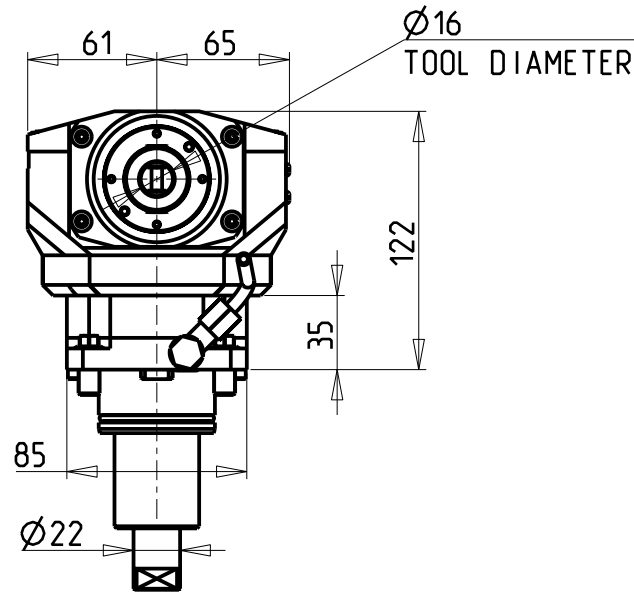
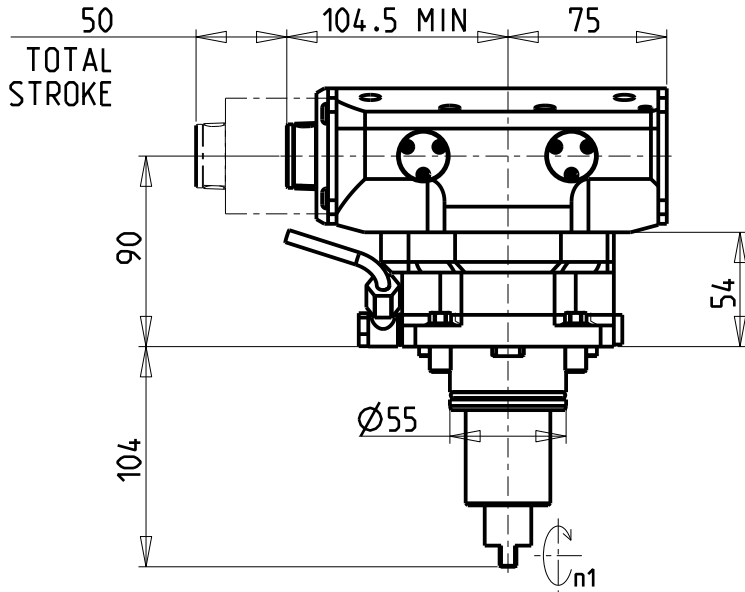
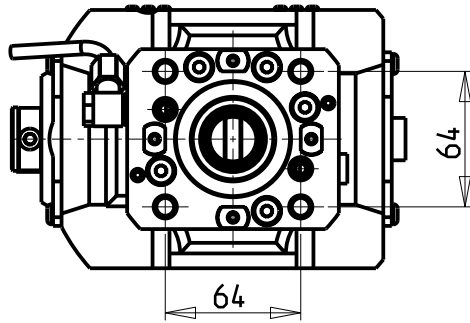

Cod. MT	I	RPM max n1	Reversibile 180° 180° Reversible 180° umsetzbar	Lubr. esterna Ext. coolant Aussenkuehlung	Lav. secco Dry-run Troeknen Bearb.
DW04110100	1:1	500	X	X	X

HYUNDAI-WIA (KIA)

MOD: SKT160TTMS/TTSY - LM1600TTMS/TTSY - SKT180TTMS/TTSY - LM1800TTMS/TTSY - LM2200TTSYY
 L160/230LMSA - SE2600M/Y/SY - HD2200-2600M/Y/SY (BMT55)

MODULO MOTORIZZATO BROCCIAITORE CORSA 50mm H=90mm
 Driven Broaching Toolholder 50mm stroke H=90mm
 Angetriebenes Nutzenstoßwerkzeug 50mm Hub H=90mm

M.T. srl

Via Casino Albini 480
 Tel. 0541/956034-957884
 Fax 0541/956341
 47842 S. GIOVANNI IN M. (RN)
 e-mail: mtma@mtmarchetti.com
 http://www.mtmarchetti.com



KIA360-2-50

Subject to change without notice.

03/2026