

KIT ADDUZIONE INTERNA (OPZIONALE)
 KIT FOR INTERNAL COOLANT (OPTIONAL)
 KIT FUER INTERNE KUEHLMITTELZUFUHR (OPTIONAL)

Ø25 cod. KIT1003006
 Ø1 1/2" cod. KIT1003004
 Ø40 cod. KIT1003003
 Ø50-Ø2" cod. KIT1003002

SOLO GUARNIZIONE (OPZIONALE)
 ONLY SEAL (OPTIONAL)
 NUR DICHTUNG (OPTIONAL)
 cod. 0520013

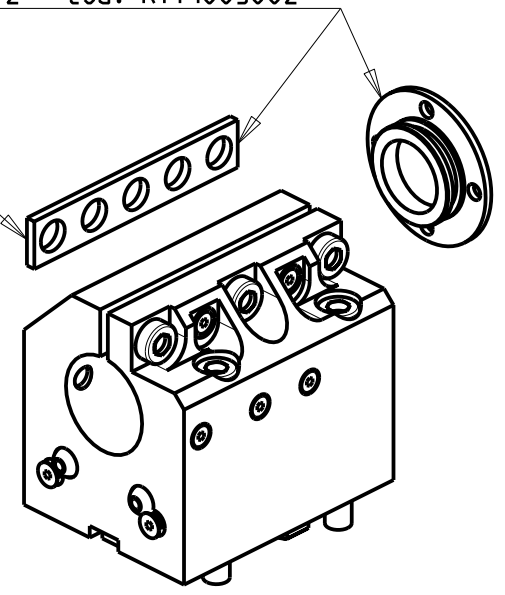

PER BOCCOLE DI RIDUZIONE VEDI PAG. TBL150-1-00
 FOR REDUCING BUSHINGS SEE PAGE TBL150-1-00
 FÜR REDUZIERBUCHSE SIEHE SEITE TBL150-1-00

Cod. MT	N°Utensili N°Tools N°Werkzeuge	Reversibile lato mandrino/contromandrino Reversible sub/main spindle side Umkehrbare Spindel-seite/ Gegenspindel-seite	Lubrificazione int. opzionale Coolant through optional Innenkuehlung Optional	Lubrificazione est. Ext. coolant Aussenkuehlung	Misure Dimensions Masse	D	A	B	H	H1
0832500	1	X	X	X	mm	25	55	55	33	105
0834000	1	X	X	X	mm	40	64	46	40	112
0833810	1	X	X	X	Inch	1 1/2"	64	46	40	112
0835000	1	X	X	X	mm	50	64	46	46.5	118
0835080	1	X	X	X	Inch	2"	64	46	46.5	118

HYUNDAI-WIA (KIA)

MOD: SKT250M/LM/MS - SKT300M/LM/MS - L300M/LM/MS/LMS - L2000/2100/2600/3000Y/SY - HD2600/3100 (BMT65)

PORTAUTENSILE ASSIALE PER BARENO Ø25 / Ø40mm / Ø1 1/2" / Ø50mm / Ø2" H=72mm

Axial single boring bar holder Ø25 / Ø40mm / Ø1 1/2" / Ø50mm / Ø2" H=72mm

Axial Bohrhälter Ø25 / Ø40mm / Ø1 1/2" / Ø50mm / Ø2" H=72mm

M.T. srl
 Via Casino Albini 480
 Tel. 0541/956034-957884
 Fax 0541/956341
 47842 S. GIOVANNI IN M. (RN)
 e-mail: mtma@mtmarchetti.com
 http://www.mtmarchetti.com



KIA610-3-20

Subject to change without notice.

03/2024