

ATTENZIONE - ATTENTION - ACHTUNG

- Per lo smontaggio degli utensili utilizzare sempre la chiave di contrasto come indicato nel manuale d'uso.
- For disassembly of the tools use always the contrast key as mentioned in the user instructions.
- Fuer das Abmontieren der Werkzeuge immer den Gegenschlüssel benutzen wie in der Bedienungsanleitung erwaeht.

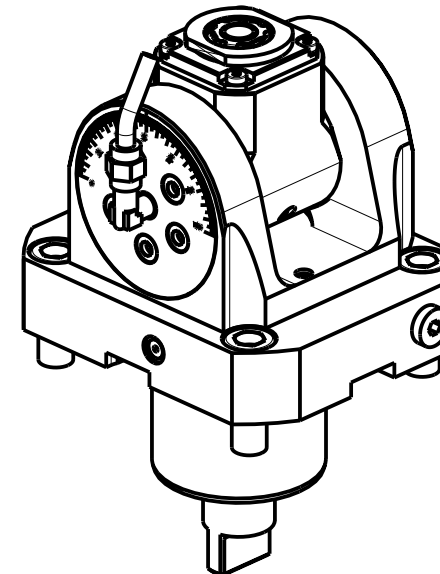

Cod. MT	Mandrino Spindle Spindel	I	RPM	Coppia Max Max Torque Max Drehmoment	Lubrificazione int. Coolant through Innenkuehlung	Lubrificazione est. Ext. coolant Aussenkuehlung	CHIAVI INCLUSE Keys included Schluessel inbegriffen			
							C HUB19_SP3	C HUB32	C HTAER16ZC	C HESL10
MNL0640316	ERA16	1:2	12000	8Nm	-	X	C HUB19_SP3	C HUB32	C HTAER16ZC	C HESL10
MNL0640416	ERA16	1:2	12000	8Nm	P=70bar	X	C HUB19_SP3	C HUB32	C HTAER16ZC	C HESL10

DMG-MORI

NL1500/2000/2500/3000 12 ST. - NLX1500/2000/2500/3000 12 ST. - NLX2500 2ND GEN. 12ST. - NLX4000 - NZL2000/2500 NZX2500 (BMT60) - NT4200/4250/4300/5400 - NTX2000/2500/3000 2ND GEN. 10ST. - CTX2500 (BMT60)

MODULO MOTORIZZATO ORIENTABILE +/-90° MOLTIPLICATO I=1:2

+/-90° adjustable angle driven tool geared-up I=1:2

Angetriebenes Werkzeug schwenkbar +/-90° uebersetzt I=1:2

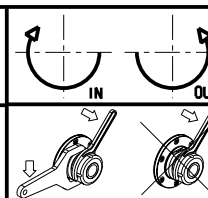

M.T. srl

Via Casino Albini 480
Tel. 0541/956034-957884
Fax 0541/956341
47842 S. GIOVANNI IN M. (RN)
e-mail: mtma@mtmarchetti.com
http://www.mtmarchetti.com



MNL336-1-00

Subject to change without notice.

10/2024