

PER ORDINARE LA VERSIONE SX
AGGIUNGERE "LC" AL CODICE IN TABELLA.
ES: MNL0464010 DIVENTA MNL0464010LC

TO ORDER LEFT VERSION
ADD A "LC" IN THE CODE-CHARTS.
EXAMPLE: MNL0464010 BECOMES MNL0464010LC

UM DIE LINKE-VERSION ZU BESTELLEN, BEI DER
ARTIKELBEZEICHNUNG "LC" HINZUFUEGEN.
BEISPIEL: MNL0464010 WIRD DANN MNL0464010LC

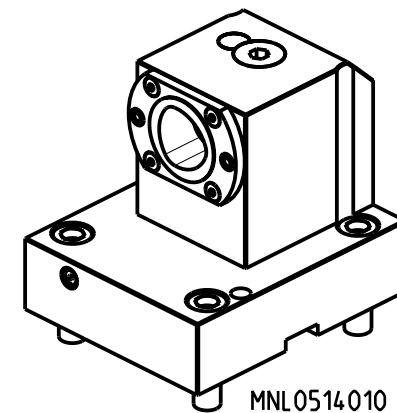

MNL0514010

Cod. MT	N°Utensili N°Tools N°Werkzeuge	Lubrificazione int. Coolant through Innenkuehlung	Reversibile lato mandrino/contromandrino Reversible sub/main spindle side Umkehrbare Spindel-seite/ Gegenspindel-seite	TAGLIA Size Masse	L1	L2	L3
MNL0514010	1	X	X	C4	114	21	68
MNL0515010	1	X	X	C5	122	31	83

DMG-MORI

NL1500/2000/2500/3000 12 STAZIONI - NLX1500/2000/2500/3000 12 STAZIONI - NLX4000 - NZL2000/2500 - NZX2500 (BMT60)
NT4200/4250/4300/5400 - NTX2000/2500/3000 2ND GEN. 10ST. - CTX2500 (BMT60)

PORTAUTENSILE ASSIALE SINGOLO ARRETRATO MT CAPTO

Axial rear-set boring single static tool MT CAPTO

Axial Single-Werkzeughalter zurueckversetzt MT CAPTO

Subject to change without notice.

M.T. srl

Via Casino Albini 480
Tel. 0541/956034-957884
Fax 0541/956341
47842 S. GIOVANNI IN M. (RN)
e-mail: mtma@mtmarchetti.com
http://www.mtmarchetti.com



MNL555-A-40

03/2024