

KIT ADDUZIONE INTERNA (OPZIONALE)
 KIT FOR INTERNAL COOLANT (OPTIONAL)
 KIT FUER INTERNE KUEHLMITTELZUFUHR (OPTIONAL)
 cod. KIT1000001

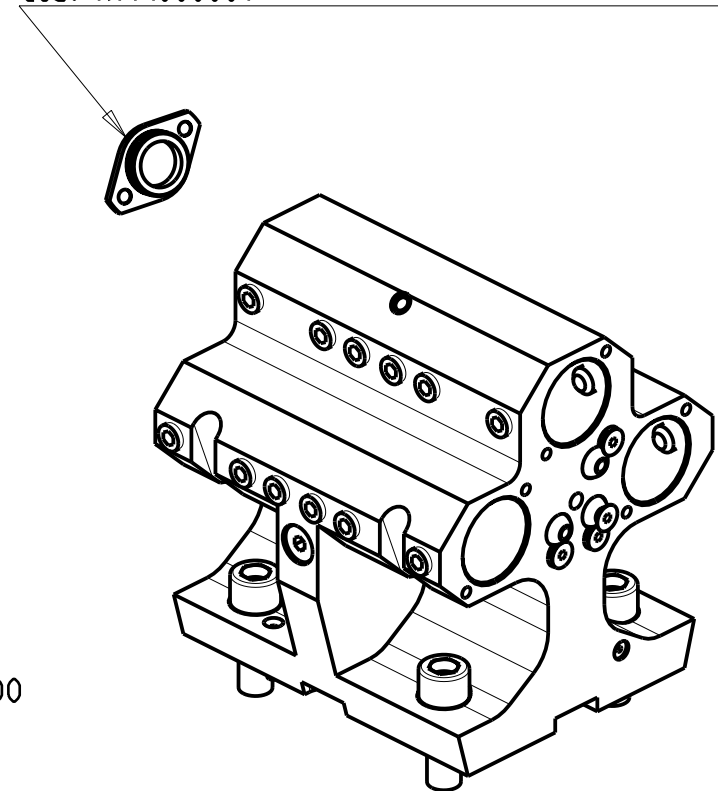

PER BOCCOLE DI RIDUZIONE VEDI PAG. TBL150-1-00
 FOR REDUCING BUSHINGS SEE PAGE TBL150-1-00
 FUR REDUZIERBUCHSE SIEHE SEITE TBL150-1-00

Cod. MT	N°Utensili N°Tools N°Werkzeuge	Lubrificazione int. Coolant through Innenkuehlung	Lubrificazione est. Ext. coolant Aussenkuehlung	Misure Dimensions Masse	D	H
MNL0093200	3+3	X	X	mm	32	40
MNL0093175	3+3	X	X	Inch	1 1/4"	1 1/2"

DMG-MORI

NL1500/2000/2500/3000 12 STAZIONI - NLX1500/2000/2500/3000 12 STAZIONI - NLX4000 - NZL2000/2500 - NZX2500 (BMT60)
 NTX2000/2500/3000 2ND GEN. 10ST. - CTX2500 (BMT60)

PORTAUTENSILE ASSIALE PER BARENO 3+3 POSIZIONI Ø32mm / Ø1 1/4"

Axial 3+3 position boring bar holder Ø32mm / Ø1 1/4"

Axial Bohrhalter 3+3 Positionen Ø32mm / Ø1 1/4"

Subject to change without notice.

M.T. srl

Via Casino Albini 480
 Tel. 0541/956034-957884
 Fax 0541/956341
 47842 S. GIOVANNI IN M. (RN)
 e-mail: mtma@mtmarchetti.com
 http://www.mtmarchetti.com



MNL912-1-00

03/2024