

POSSIBILITA' DI
ROTAZIONE 360°

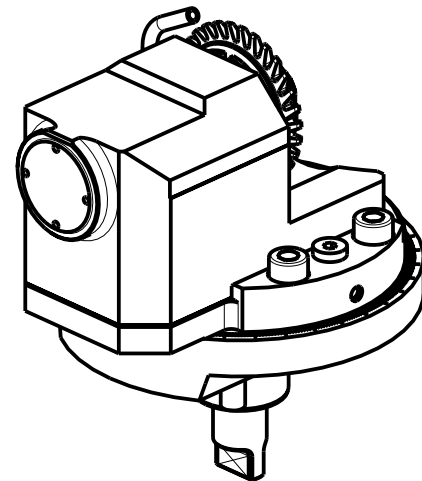
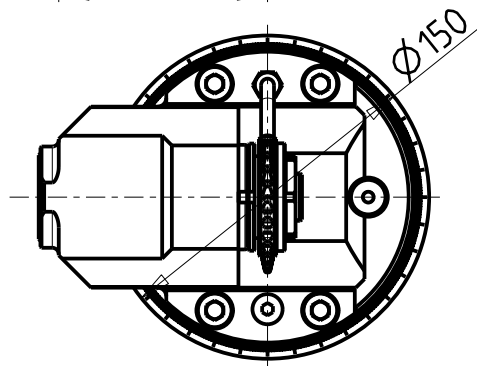

Cod. MT	Mandrino Spindle Spindel	I	RPM	Coppia Max Max Torque Max Drehmoment	Lubrificazione est. Ext. coolant Aussehenkuehlung	ØD	H	CHIAVI INCLUSE Keys included Schlüssel einbegriffen		
MNZ0438022	Ø22x12	1:1	6000	50Nm	X	63-70-80	MAX 12	CHUB38	CHESL07	CHESL08
MNZ0438125	Ø1"x12	1:1	6000	50Nm	X	63-70-80	MAX 12	CHUB38	CHESL07	CHESL08

DMG-MORI

NZ-NZX1500/2000 - NZX2500 (BMT40) - NT3100/3150/3200 - NL1500/2000/2500 20 STAZ. - NLX1500/2000/2500 20 STAZ. - NT1000/2000 - NTX500 (BMT40) - NTX1000/2000
NTX1000/2000/2500/3000 2ND GEN. 12ST. - DURATURN 2050MC/2550MC - ALC/ALX1500/2000/2500 (BMT40) - ECOTURN 450 (BMT40) - NZ DUE/TRE/QUATTRO (BMT40)

MODULO MOTORIZZATO PER VITI SENZA FINE

Driven tool for worm screws

Angetriebenes Werkzeug fuer schrauben ohne ende

Subject to change without notice.

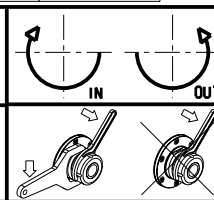

M.T. srl

Via Casino Albini 480
Tel. 0541/956034-957884
Fax 0541/956341

47842 S. GIOVANNI IN M. (RN)
e-mail: mtma@mtmarchetti.com
http://www.mtmarchetti.com



MNZ359-1-00

03/2024