

ATTENZIONE - ATTENTION - ACHTUNG

- Per lo smontaggio degli utensili utilizzare sempre la chiave di contrasto come indicato nel manuale d'uso.
- For disassembly of the tools use always the contrast key as mentioned in the user instructions.
- Fuer das Abmontieren der Werkzeuge immer den Gegenschlüssel benutzen wie in der Bedienungsanleitung erwäehnt.

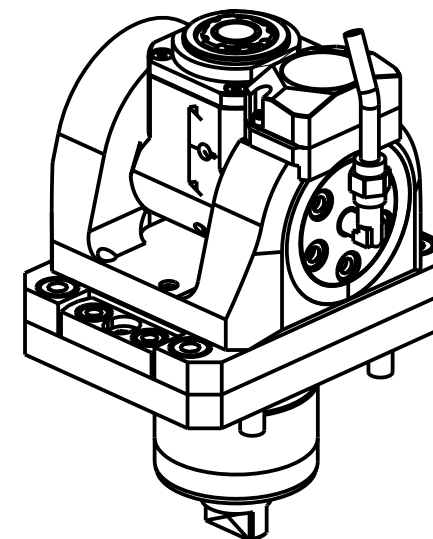

Cod. MT	Mandrino Spindle Spindel	I	RPM	Coppia Max Max Torque Max Drehmoment	Reversibile lato mandrino/contromandrino Reversible sub/main spindle side Umkehrbare Spindel-seite/ Gegenspindel-seite	Lubrificazione int. Coolant through Innenkuehlung	Lubrificazione est. Ext. coolant Aussenkuehlung	CHIAVI INCLUSE Keys included Schluessel inbegriffen			
								CHUB36	CHUB22	CHESL06	CHTAER20ZC
MYA0125120	ERA20	1:1	6000	30Nm	X	-	X	CHUB36	CHUB22	CHESL06	CHTAER20ZC
MYA0125220	ERA20	1:1	6000	30Nm	X	P=70bar	X	CHUB36	CHUB22	CHESL06	CHTAER20ZC

MIYANO

MOD: ABX-51/64/80 SYY/THY

MODULO MOTORIZZATO ORIENTABILE +/-90° CON NONIO DIGITALE H=60mm

+/-90° adjustable angle driven tool with digital display H=60mm

Angetriebenes Werkzeug schwenkbar +/-90° mit digital display H=60mm

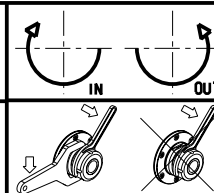

M.T. srl

Via Casino Albini 480

Tel. 0541/956034-957884

Fax 0541/956341

47842 S. GIOVANNI IN M. (RN)

e-mail: mtma@mtmarchetti.com

http://www.mtmarchetti.com



MYA335-3-01

Subject to change without notice.

03/2024