

POSSIBILITA' DI LAVORO M3/M4
 OPTION OF M3/M4 WORKING
 ARBEITSMOEGlichkeit M3/M4

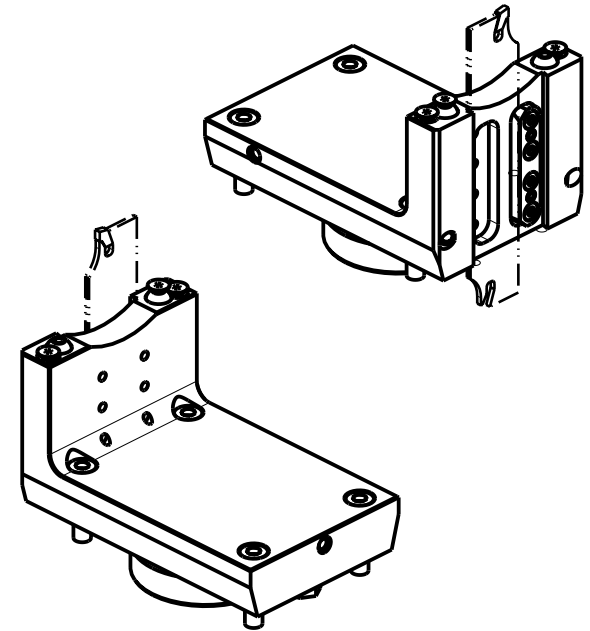

DOTAZIONI - SUPPLIED WITH - AUSSTATTUNG

N°1 - LAMA - BLADE - KLINGE ISCAR H=32 Sp. 3/4mm
 (KENNAMETAL OPTIONAL)

N°10 - INSERTI - INSERTS - EINLAGEN

N°1 - CHIAVE A T PER MONTAGGIO INSERTI
 - T-WRENCH FOR INSERT SET UP
 - T-SCHLUESSEL FUER EINSATZSTUECK-MONTAGE

Cod. MT	N°Utensili N°Tools N°Werkzeuge	Lubr.esterna Ext. coolant Aussenkuehlung
MZK0330132	1	X

MAZAK

MOD: QUICK TURN SMART 100M/150M/200M/250M - QT 100/200/250M 12ST.
 QTC100/200/300M - QTE100/200/300M - QTU 200/250/350M - QT-Ez 8/10/12M

PORTAUTENSILE RADIALE PER LAMA

Radial blade holder

Radial Abstechhalter

M.T. srl

Via Casino Albini 480
 Tel. 0541/956034-957884
 Fax 0541/956341
 47842 S. GIOVANNI IN M. (RN)
 e-mail: mtma@mtmarchetti.com
 http://www.mtmarchetti.com



MZK510-7-00

Subject to change without notice.

03/2024