

INCLINAZIONE
REGOLABILE $\pm 20^\circ$

-LA FUNZIONE DI POLIGONATURA/DENTATURA
DEVE ESSERE INSTALLATA SULLA MACCHINA
-POLYGON CUTTING/GEAR HOBGING FUNCTION
MUST BE INSTALLED ON THE MACHINE
-DIE FUNKTION FÜR POLYGON-BZW. VERZÄHNUNGSFRÄSEN
MUSS AUF DER MASCHINE FREIGESCHALTET WERDEN

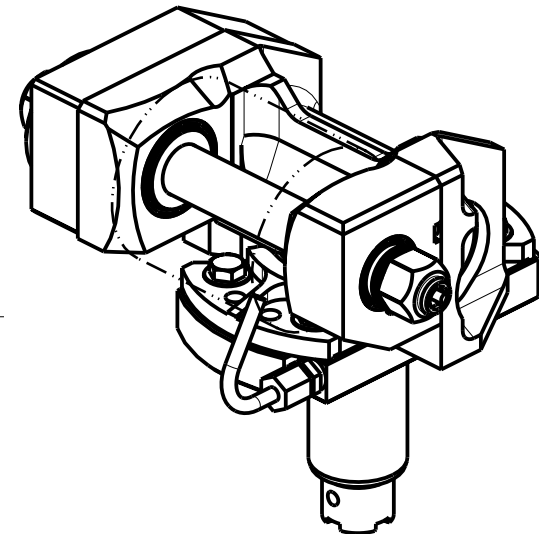

TORRETTE RADIALI
RADIAL TURRETS
RADIAL REVOLVER

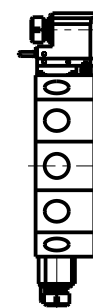

PER ALBERI E DISTANZIALI VEDI PAG. TBL250-1-00
FOR SHAFT END SPACER SEE PAGE TBL250-1-00
FUER DORN UND ABSTANDSSTUECK SEITE TBL250-1-00

DOTAZIONI - SUPPLIED WITH - AUSSTATTUNG

mm / inch	- N°1 ALBERO + DISTANZIALI - N°1 SHAFT + SPACER - N°1 DORN + ABSTANDSSTUECK
-----------	---

Cod. MT	I	RPM MAX	Coppia Max Max Torque Max Drehmoment	Lubr.esterna Ext. coolant Aussenkuehlung	D (mm)	D (Inch)	CHIAVI INCLUSE Keys included Schluessel inbegriffen		
							CHUB13	CHUB24	CHESL08
1260KU_PCR_40B01	1:1	4000	60Nm	X	16-22-27-32	3/4"-1"-1 1/4"	CHUB13	CHUB24	CHESL08
1260KU_PCR_40B11	2:1	2000	80Nm	X	16-22-27-32	3/4"-1"-1 1/4"	CHUB13	CHUB24	CHESL08

OKUMA

MOD: LB25/400 - LR25 - LU25M - LU400M

MODULO MOTORIZZATO PORTACREATORE VDI40

Driven gear hobber VDI40

Angetriebenes Zahnradwaelzfraes-Werkzeug VDI40

Subject to change without notice.

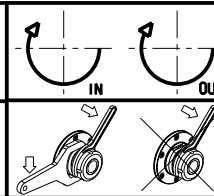

M.T. srl

Via Casino Albini 480
Tel. 0541/956034-957884
Fax 0541/956341

47842 S. GIOVANNI IN M. (RN)
e-mail: mtma@tmarchetti.com
http://www.tmmarchetti.com



OKU340-3-00

03/2024