

versione dx
right version
version rechts

versione sx
left version
version links

versione universale
universal version
universal version

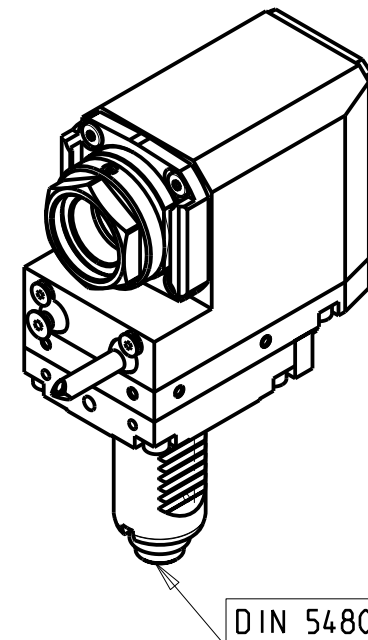
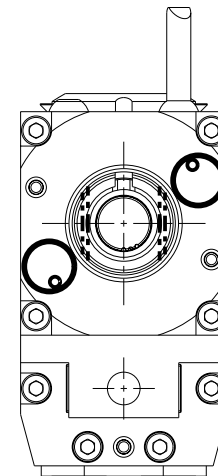
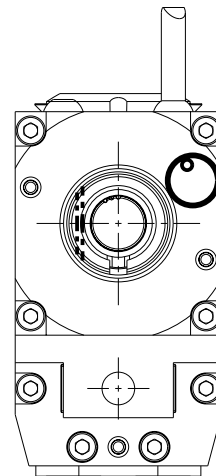
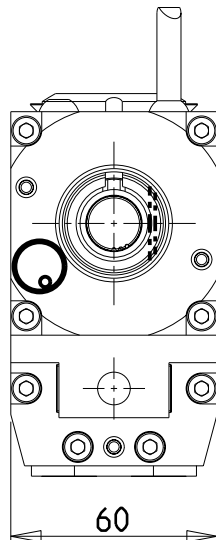

DIN 5480

PER PORTAUTENSILI MODULARI MTSK-32 VEDI PAG. TBL300-1-32
FOR MTSK-32 QUIK CHANGE TOOLHOLDERS CLAMPINGS SEE PAGE TBL300-1-32
FUER MTSK-32 MODULARE WERKZEUGAUFNAHMEN SIEHE SEITE TBL300-1-32

Cod. MT			Mandrino Spindle Spindel	I (n1:n2)	RPM max n2	Coppia Max Max Torque Max Drehmoment M2 (Nm)	Lubrificazione int. Coolant through Innenkuehlung Pmax (bar)	Lubr.esterna Ext. coolant Aussenkuehlung	Lav. secco Dry-run Trocken Bearb.	B	CHIAVI NON INCLUDE Keys not included Schlüssel nicht einbegriffen	
versione dx right version version rechts	versione sx left version version links	versione universale universal version universal version										
SAU0640132	SAU0641132	SAU0642132	MTSK-32	1:1	6000	32	-	X	X	73.5	CHUB36	OKU0290009 ▪
SAU0640232	SAU0641232	SAU0642232	MTSK-32	1:1	6000	32	100 (diag. 2)	X	X	83.5	CHUB36	OKU0290009 ▪

- Chiave inclusa
- Key included
- Schlüssel einbegriffen

SAUTER
VDI 30

MODULO MOTORIZZATO RADIALE ARRETRATO MTSK VDI30 DIN 5480 H=75mm
Radial MTSK rear-set driven tool VDI30 DIN 5480 H=75mm
Radial MTSK angetriebenes Werkzeug zurueckversetzt VDI30 DIN 5480 H=75mm

M.T. srl

Via Casino Albini 480
Tel. 0541/956034-957884
Fax 0541/956341
47842 S. GIOVANNI IN M. (RN)
e-mail: mtma@mtmarchetti.com
http://www.mtmarchetti.com



SAU018-2-60-K

Subject to change without notice.

03/2026