

versione dx  
right version  
version rechts

versione sx  
left version  
version links

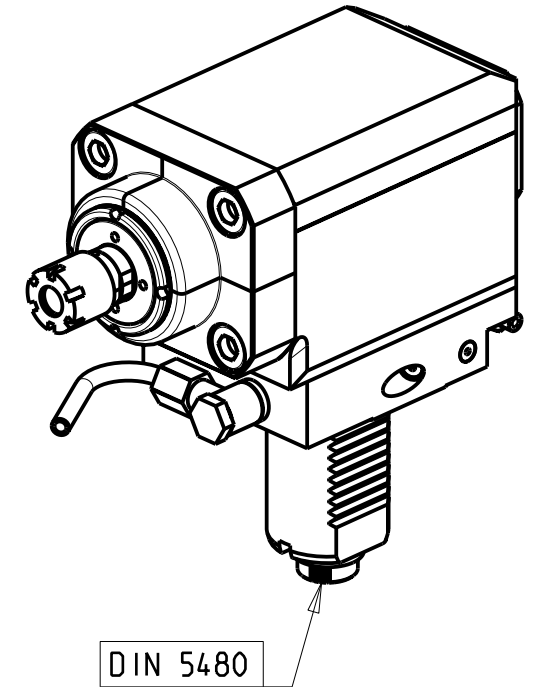
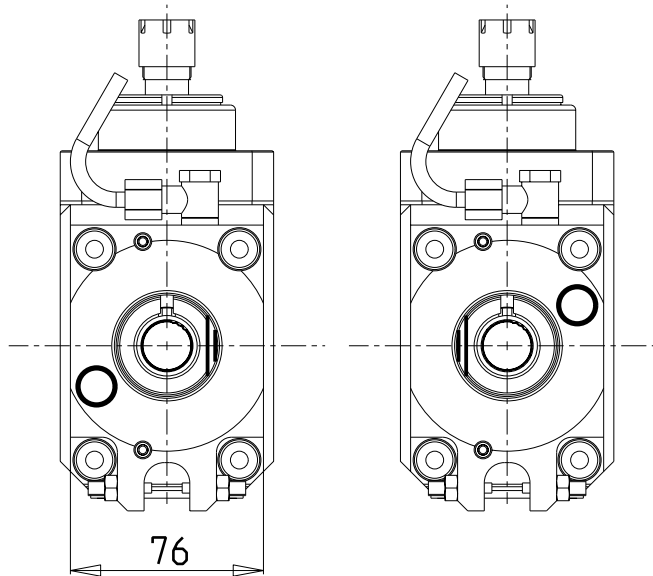

Cod. MT		Mandrino Spindle Spindel	I (n1:n2)	RPM max n2	Coppia Max Max Torque Max Drehmoment M2 (Nm)	Lubr.esterna Ext. coolant Aussenkuehlung	Lav. secco Dry-run Trocken Bearb.	CHIAVI INCLUSE Keys included Schluessel einbegriffen	
versione dx right version version rechts	versione sx left version version links							CHUB17	CHMNER16
SAU0580016	SAU0581016	ER16	1:3	18000	10	X	-	CHUB17	CHMNER16

SAUTER  
VDI 40

MODULO MOTORIZZATO RADIALE MOLTIPLICATO I=1:3 VDI40 DIN 5480 H=70mm  
Radial geared-up I=1:3 driven tool VDI40 DIN 5480 H=70mm  
Radial angetriebenes Werkzeug uebersetzt I=1:3 VDI40 DIN 5480 H=70mm

**M.T. srl**

Via Casino Albini 480  
Tel. 0541/956034-957884  
Fax 0541/956341  
47842 S. GIOVANNI IN M. (RN)  
e-mail: mtma@mtmarchetti.com  
http://www.mtmarchetti.com



SAU018-3-04

Subject to change without notice.

03/2026