

versione dx  
right version  
version rechts

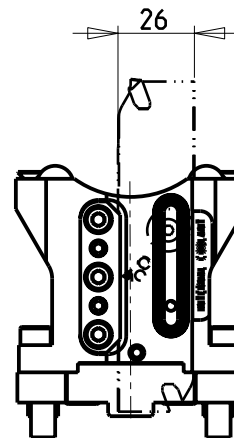

versione sx  
left version  
version links

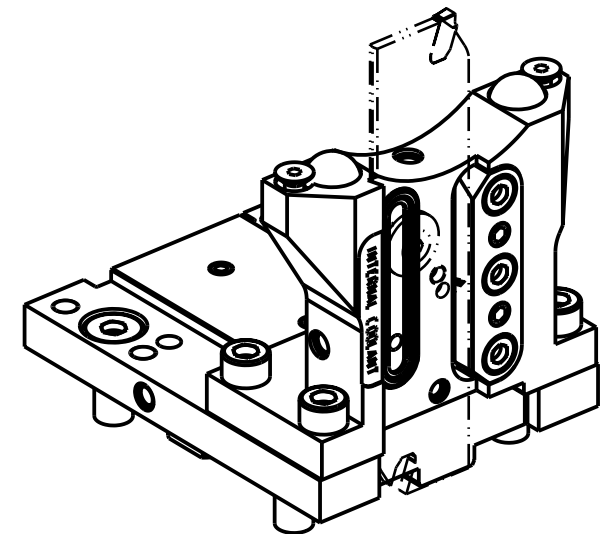

**KIT LAME NON INCLUSI (OPZIONALI)**  
**BLADES NOT SUPPLIED WITH (OPTIONAL)**  
**KLINGEN NICHT INBEGRIFFEN (OPTIONAL)**

- LAMA-BLADE-KLINGE SANDVIK H=26 sp.3 cod. QD\_NN2G36C21A  
+INSERTI-INSERTS-EINLAGEN cod. QD\_NG\_0300\_0002\_CM\_1145 (10 pz.)
- LAMA-BLADE-KLINGE ISCAR H=26 sp.3 cod. SGFH\_26K\_3  
+INSERTI-INSERTS-EINLAGEN cod. 6011365 (10pz.)

Cod. MT		N°Utensili N°Tools N°Werkzeuge	Reversibile lato mandrino/contromandrino Reversible sub/main spindle side Umkehrbare Spindel-seite/ Gegenspindel-seite	Lubr.esterna Ext. coolant Aussenkuehlung	Lubr.interna Coolant through Innenkuehlung
versione dx right version version rechts	versione sx left version version links				
DW 02950126R	DW 02950126L	1	X	X	P=70bar

VICTOR

MOD: VTURN-NP16CM

PORTAUTENSILE RADIALE PER LAMA CON LUBRIFICAZIONE INTERNA

Radial blade holder with internal coolant

Radial Abstechhalter mit Innenkuehlung

Subject to change without notice.

**M.T. srl**

Via Casino Albini 480  
Tel. 0541/956034-957884  
Fax 0541/956341  
47842 S. GIOVANNI IN M. (RN)  
e-mail: mtma@mtmarchetti.com  
http://www.mtmarchetti.com



VCT520-5-15

03/2024