

CUSCINETTI MAGGIORATI PER LAVORAZIONI PESANTI

Reinforced bearings for
heavy machining

Vergroesserte Lager fuer
schwerere Bearbeitungen

ATTENZIONE - ATTENTION - ACHTUNG

- VERIFICARE LE MISURE DI INGOMBRO PER POSSIBILE INTERFERENZA SU ALCUNI MODELLI DI MACCHINE
- Please check the overall sizes for possible interferences on some machine models
- Bitte überprüfen sie das ausmass um mögliche interferenzen auf einigen maschinen modellen zu vermeiden

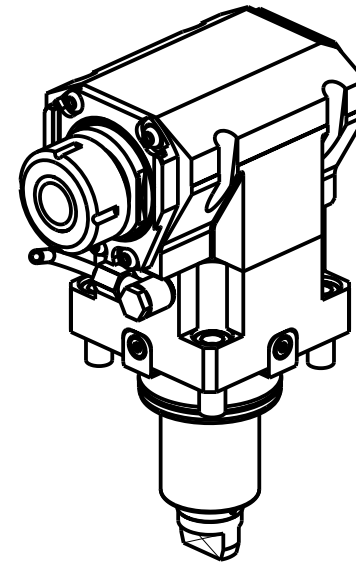
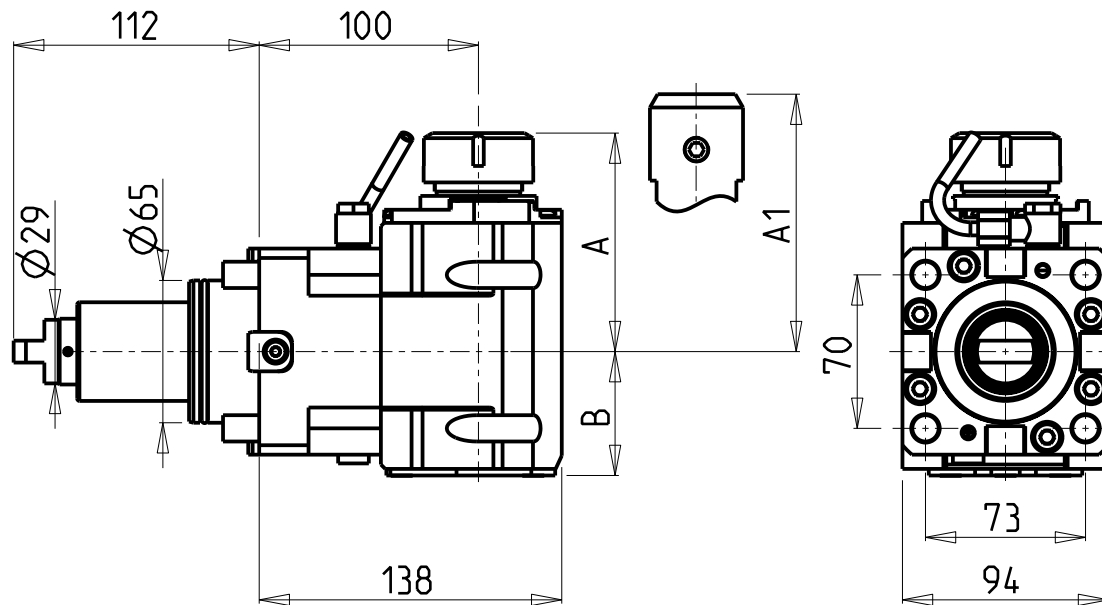

• Chiave inclusa

• Key included

• Schlüssel inbegriffen

Cod. MT	Mandrino Spindle Spindel	I	RPM	Coppia Max Max Torque Max Drehmoment	Reversibile lato mandrino/contromandrino Reversible sub/main spindle side Umkehrbare Spindel-seite/ Gegenspindel-seite	Lubr.interna Coolant through Innenkuehlung	Lubr.esterna Ext. coolant Aussenkuehlung	A	A1	B	CHIAVI NON INCLUDE Keys not included Schlüssel nicht einbegriffen	
DW 02490132	ER32	1:1	6000	110Nm	X	-	X	99.7	-	56.5	CHSTER32	OKU0650004
DW 02490232	ER32	1:1	6000	110Nm	X	P=70bar	X	99.7	-	67.5	CHSTER32	OKU0650004
DW 02490725	WELDON25	1:1	6000	110Nm	X	-	X	-	106	56.5	-	-
DW 02490825	WELDON25	1:1	6000	110Nm	X	P=70bar	X	-	106	67.5	-	-

YCM
MOD: BTX250SY - NT2000/2500 12 STAZIONI

MODULO MOTORIZZATO ASSIALE MAGGIORATO H=100mm
Axial reinforced driven tool H=100mm
Axial angetriebenes Werkzeug vergroessert H=100mm

Subject to change without notice.

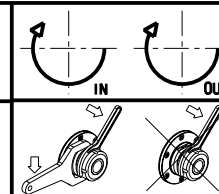

M.T. srl

Via Casino Albini 480
Tel. 0541/956034-957884
Fax 0541/956341
47842 S. GIOVANNI IN M. (RN)
e-mail: mtma@mtmarchetti.com
http://www.mtmarchetti.com



YCM170-2-30