

KIT ADDUZIONE INTERNA (OPZIONALE)
 KIT FOR INTERNAL COOLANT (OPTIONAL)
 KIT FUER INTERNE KUEHLMITTELZUFUHR (OPTIONAL)
 Ø80 cod. KIT1002013
 Ø3" cod. KIT1002014

SOLO GUARNIZIONE (OPZIONALE)
 ONLY SEAL (OPTIONAL)
 NUR DICHTUNG (OPTIONAL)
 cod. MNL0310005

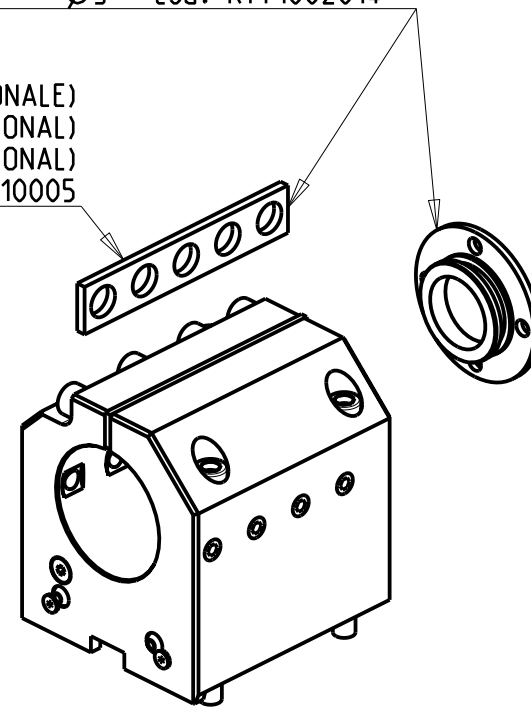

Cod. MT	N°Utensili N°Tools N°Werkzeuge	Reversibile lato mandrino/contromandrino Reversible sub/main spindle side Umkehrbare Spindel-seite/ Gegenspindel-seite	Lubrificazione int. opzionale Coolant through optional Innenkuehlung Optional	Lubrificazione est. Ext. coolant Aussenkuehlung	Misure Dimensions Masse	D
DW00348000	1	X	X	X	mm	80
DW00347620	1	X	X	X	Inch	3"

YCM

TC 46

PORTAUTENSILE ASSIALE PER BARENO Ø80mm / Ø3" H=85mm
 Axial single boring bar holder Ø80mm / Ø3" H=85mm
 Axial Bohrhälter Ø80mm / Ø3" H=85mm

Subject to change without notice.

M.T. srl

Via Casino Albini 480
 Tel. 0541/956034-957884
 Fax 0541/956341
 47842 S. GIOVANNI IN M. (RN)
 e-mail: mtma@mtmarchetti.com
 http://www.mtmarchetti.com



YCM580-3-20

03/2024